

## Breakdown phenomenon and settlement

Phenomenon	Reasons	Maintenance
Without steam	<ol style="list-style-type: none"> <li>1.steam generator without water.</li> <li>2.inside infrared pipe burn out of steam generator.</li> <li>3.block of steam spray mouth.</li> <li>4.probe out off control.</li> <li>5.the temperature inside steam room is over the temperature what were set.</li> <li>6.after fill into water it is still not the time for steam working.</li> <li>7.it is overtime for the setting time.</li> <li>8.unconnect with the control wire.</li> </ol>	<ol style="list-style-type: none"> <li>1.check if the switch of water in be turn on or not.</li> <li>2.change the infrared pipe.</li> <li>3.get rid of mess.</li> <li>4.check the connection wire and change the probe.</li> <li>5.waiting decrease the temperature.</li> <li>6.be waiting few minutes.</li> <li>7.adjust the setting time.</li> <li>8.connect to control wire.</li> </ol>
Water pipe leaking	<ol style="list-style-type: none"> <li>1.plastic seal ring be connected untightly.</li> <li>2.screws unlock.</li> <li>3.connection is glued not good.</li> <li>4.water pipe be damaged.</li> </ol>	<ol style="list-style-type: none"> <li>1.change the plastic seal ring.</li> <li>2.screws should be installed tightly.</li> <li>3.get rid of the PVC glue then stick the glue again till it is be well done.</li> <li>4.change the water pipe.</li> </ol>
Computer panel under control	<ol style="list-style-type: none"> <li>1.power not be connected well,electronic leakage device without power.</li> <li>2.switch of control panel out of control.</li> </ol>	<ol style="list-style-type: none"> <li>1.get through the power again.</li> <li>2.change the computer panel.</li> </ol>
Without lighting	<ol style="list-style-type: none"> <li>1.bulb be burned.</li> <li>2.without power.</li> <li>3.switch of control panel out of control.</li> </ol>	<ol style="list-style-type: none"> <li>1.change bulb.</li> <li>2.get through power gain.</li> <li>3.maintain or change the computer panel.</li> </ol>
Telephone connection unworking	<ol style="list-style-type: none"> <li>1.telephone wire not connected well or be damaged.</li> <li>2.telephone's device be blocked.</li> </ol>	<ol style="list-style-type: none"> <li>1.check the wires of telephone and electronic box if get through or not, if there is something wrong replace by the similar wires.</li> <li>2.get rid of mess.</li> </ol>
Without sounds	<ol style="list-style-type: none"> <li>1.speaker be broken</li> <li>2.without power</li> <li>3.switch of control panel out of control</li> </ol>	<ol style="list-style-type: none"> <li>1.change the speaker</li> <li>2.get through power again</li> <li>3.maintain or change the computer panel</li> </ol>

- No advanced advice will be submit before we change our design and size.
- The pictures may be a little different from the real products.
- Our company keep the final explanation right.



**Do not dispose this product as unsorted municipal waste. Collection of such waste separately for special treatment is necessary.**

# INSTALL DIRECTION

## STEAM BATHROOM

MODEL:YH3803L



**TECHNIQUE PARAMETER**

Voltage	Frequency	Water Volatge	Power of steam generator
AC220V (±10%)	50/60Hz	0.1~0.2Mpa	3KW

**CONSTRUCTION SKETCH**

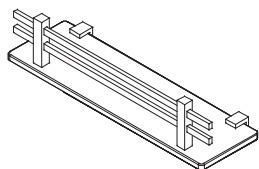

Handrail

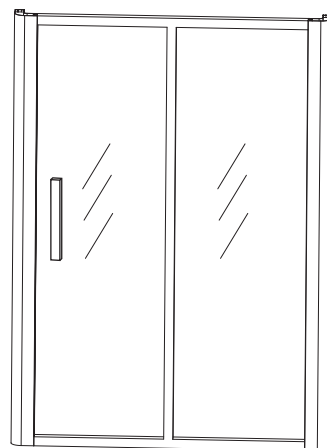

Glass door



SIZE:1380X880X2150mm

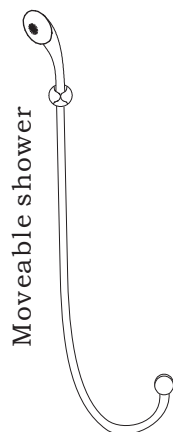

Moveable shower

**7. Radio Channel**

Press “” button will save the current frequency on the screen, 9 channels can be saved. To call out the saved channel by pressm “mem” button from 1m to 9m.

**8. Taking shower and waer massage**

Press the water switch and pour water . Get a suitable temperature , then choose The shower function according to your need . The function of the select shift ( from left to right) is acupuncture sprayer roof shower、 moveable shower bath. Turn the shift and select what you need .

**9. Water Supply**

Adjust the switch valve back to the original position. Turn off the hot-cold water supply, then switch off the external supply of hot-cold water.

**10. Drainage**

After finishing the bath, use toe to press down the drainage device for remove water.

**ATTENTION FOR USAGE**

1. Check if power and cold/hot water switch be turn on or be turn off each time before use this product.
2. Check if power of electronic leakage device be get through or not.

Checking way:

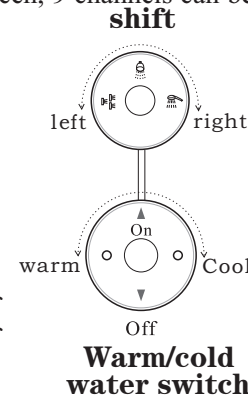

Press testing button, light of power be off, press button of restart then light of power be on. It is not being what mentioned above after operated step by step, then that shows the electronic protection device out off control or there is something wrong with the electronic leakage device, so should ask professional to check and maintain the product.

3. Turn off the main power of control panel after stop usage. The plug of power should be pull out because only turn off all the functions of control panel that is not stop the power.
4. People with hypertension or drunk are not allowed to have sauna steam bath.
5. Children should have sauna steam bath under adult's instruction.
6. Please don't shut the finger in the door in order to be hurt when get into the steam room.
7. In order to be tripped and fell down, pay more attention when get into the steam room.
8. keep clean of the tray in order to be tripped and fell down.











● USAGE ILLUSTRATION

**1. Operating manual**



Please connect to the power supply. Press “” to start the system. The screen would show up relevant signal. Time is showed on the bottom left of the screen, the default time is 30 minutes; the system tray is in the middle and the room temperature is on the bottom right. When the light is on, a symbol will show on the top right. Light can be turned on when other function is on. Press “” again to shut down the system, then the ozone reactor will start automatically for 15 minutes and water will drain out from the steam box.

**2. Radio**



When the system is on, press “” button to turn on the radio, then the screen shows up “” signal and channels. To search your favorite radio channel by press “” and “”, the frequency will show on the screen. Press “” or “” to adjust the volume, the screen shows current volume.

Press button “” for the second time to start the CD function. CD symbol “” and volume will be showed on the screen. Press button “” the third time, the system will shut radio and CD function off.

**3. Telephone**

When system is turn on, the speaker will ring up the tone if there are any phone calls. To receive or hang up by pressing “”. The screen shows up a telephone symbol “”, then you can begin the conversation by talking in front of the control panel.

**4. Steam**

When the system turns on, press “” button to start the steam function. The screen shows up relevant symbol “”. Water stream into the steam box and hit up automatically, steam will be generated in about 60 seconds. Within the procedure, the water will fill the steam box and generate steam continuously.

“” is for time setting of the steam function. Every 2 minutes of the steam period will be increased by every single press. The screen will show up the remaining time until the steam function finished. The time range is from 10minutes to 98minutes.

“” is functioning as the temperature setting, every press will increase 5°C. The temperature range is from 30°C to 60°C and is showed on the screen.

Beside all, the steam generator is made with Dry-proved and electricity leakage protection. If there are no water inside the steam generator or any electricity wastage occurs, the steam generator will automatically turn off.

Press “” again to turn off all steam function.

**5. Light**

When the system is on, press “” button to turn off the top light, press again to turn it off.

**6. Fans**

When the system is on, press “” button to turn on the fans, press again to turn it off. (parameter of the fans: AC 12V/5W)

● CONSTRUCTION SKETCH

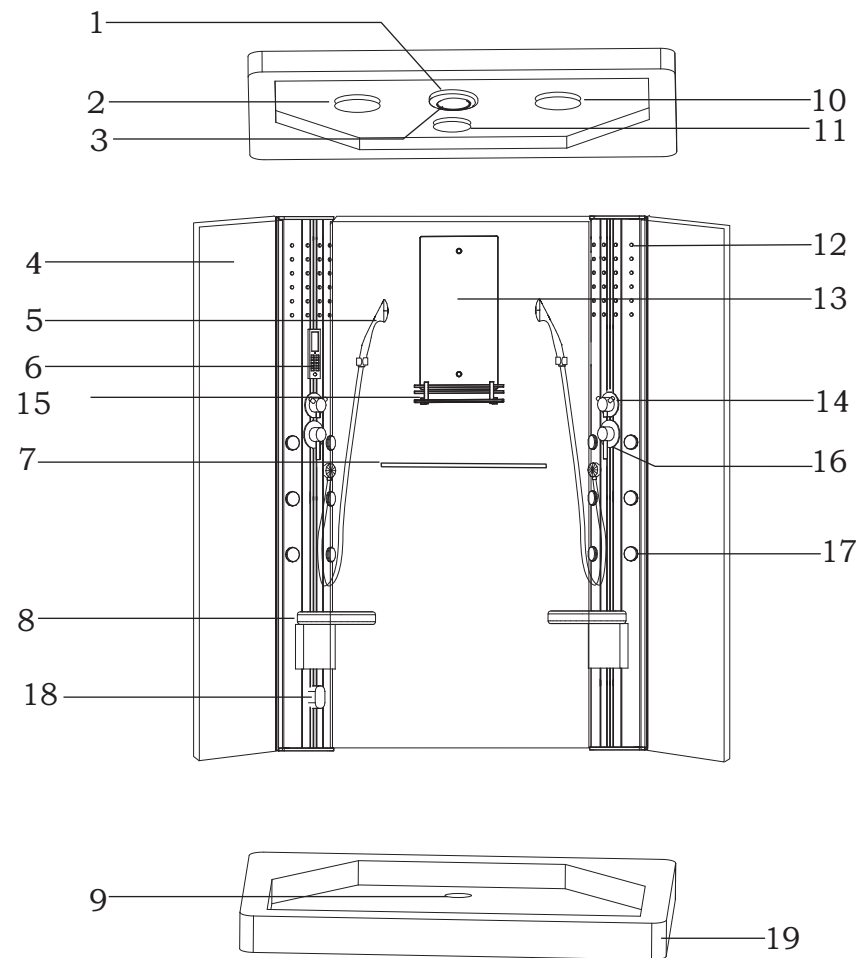

- |                   |                    |                          |
|-------------------|--------------------|--------------------------|
| 1、top light       | 8、seat             | 15、back light            |
| 2、speaker         | 9、drainage         | 16、cold/hot water switch |
| 3、top shower      | 10、exhaust fan     | 17、nozzle                |
| 4、room body       | 11、ozone           | 18、steam out             |
| 5、moveable shower | 12、decorated light | 19、bottom tray           |
| 6、control panel   | 13、mirror          |                          |
| 7、towel shelf     | 14、shift switch    |                          |

INSTALLATION SKETCH

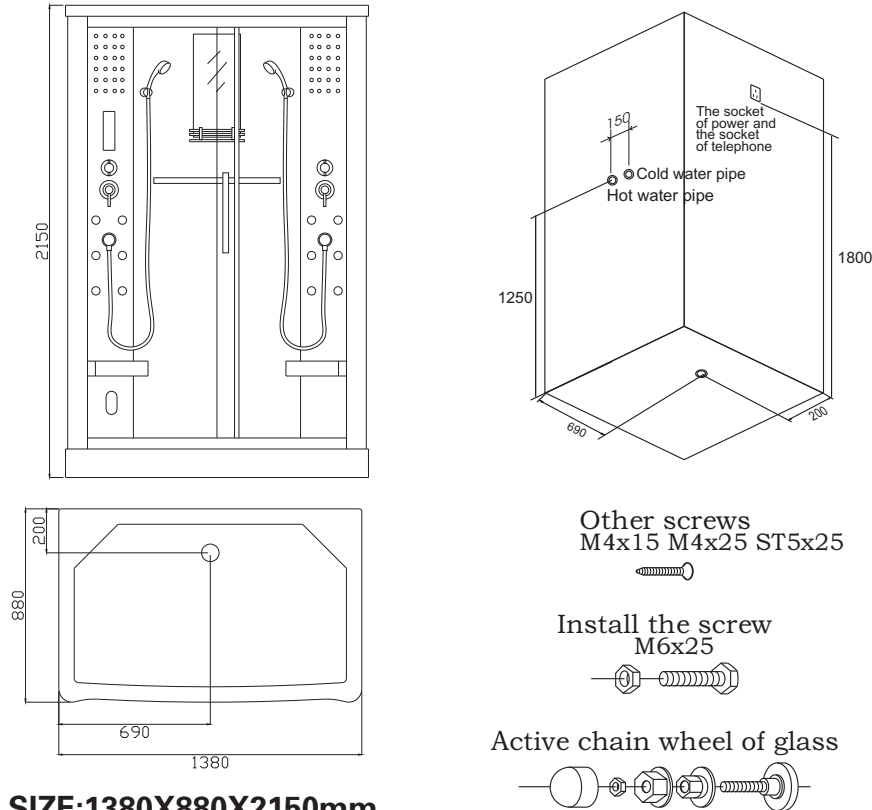

SIZE:1380X880X2150mm

ILLUSTRATION OF INSTALLATION

1. The products should be installed by technical guy who are got the certificate or those technical who are assign by dealers. The main power switch and electronic leakage device should be installed.
2. The plug of electronic should be installed above the steam generator and the length of electronic wire not less then 1800MM from the earth.
3. There are should be with main power switch for hot and cold water pipe of steam room and the water pipe should be connect to drainage water pipe.
4. Install the products according to the diagram of installation When fixed the place for the products.

MANUAL

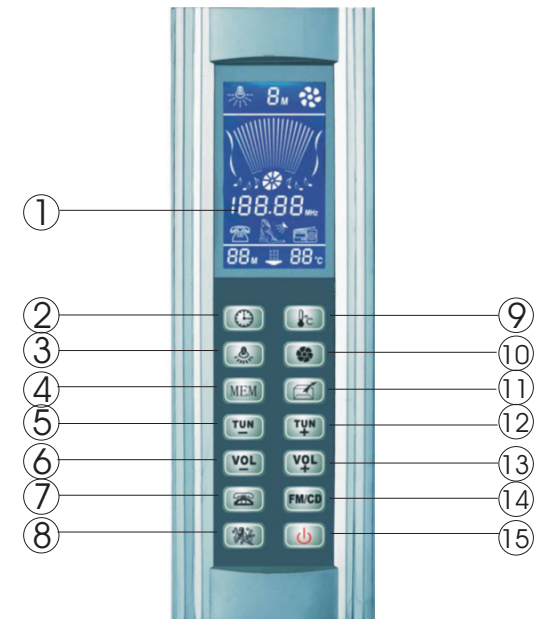

- |                  |                 |
|------------------|-----------------|
| ① Screen         | ⑨ Temperature   |
| ② Time setting   | ⑩ Fans          |
| ③ Top lamp       | ⑪ Radio channel |
| ④ Memory         | ⑫ Frequency up  |
| ⑤ Frequency down | ⑬ Volume up     |
| ⑥ Volume down    | ⑭ Radio/CD      |
| ⑦ Telephone      | ⑮ On/Off        |
| ⑧ Steam          |                 |

### DRAWING OF WATER CONNECTION

As the “” from the picture, please make the connection according to the serial number v1,v2,etc.

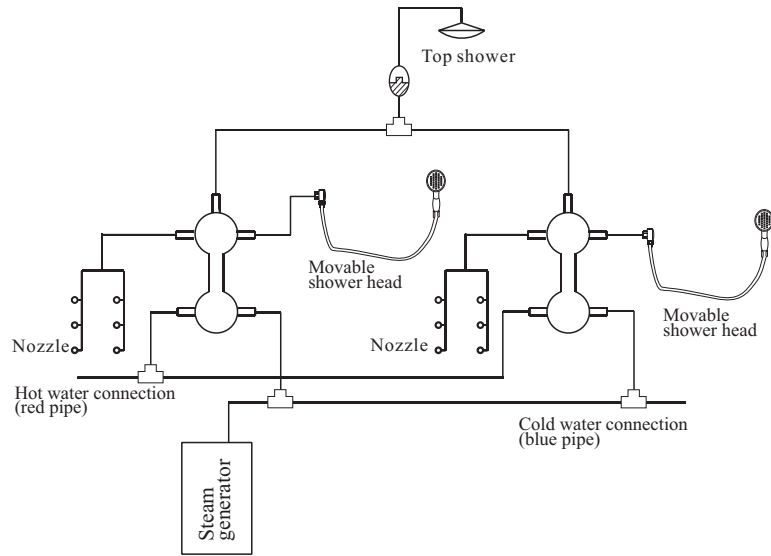

### ELECTRIC CIRCUIT SKETCH

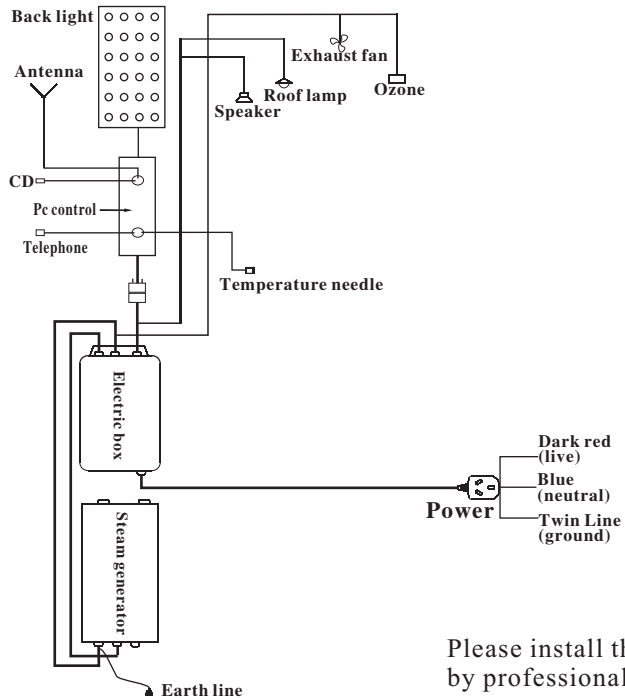

Please install the earth line safely by professional technician.

### INSTALLATION PROCESS

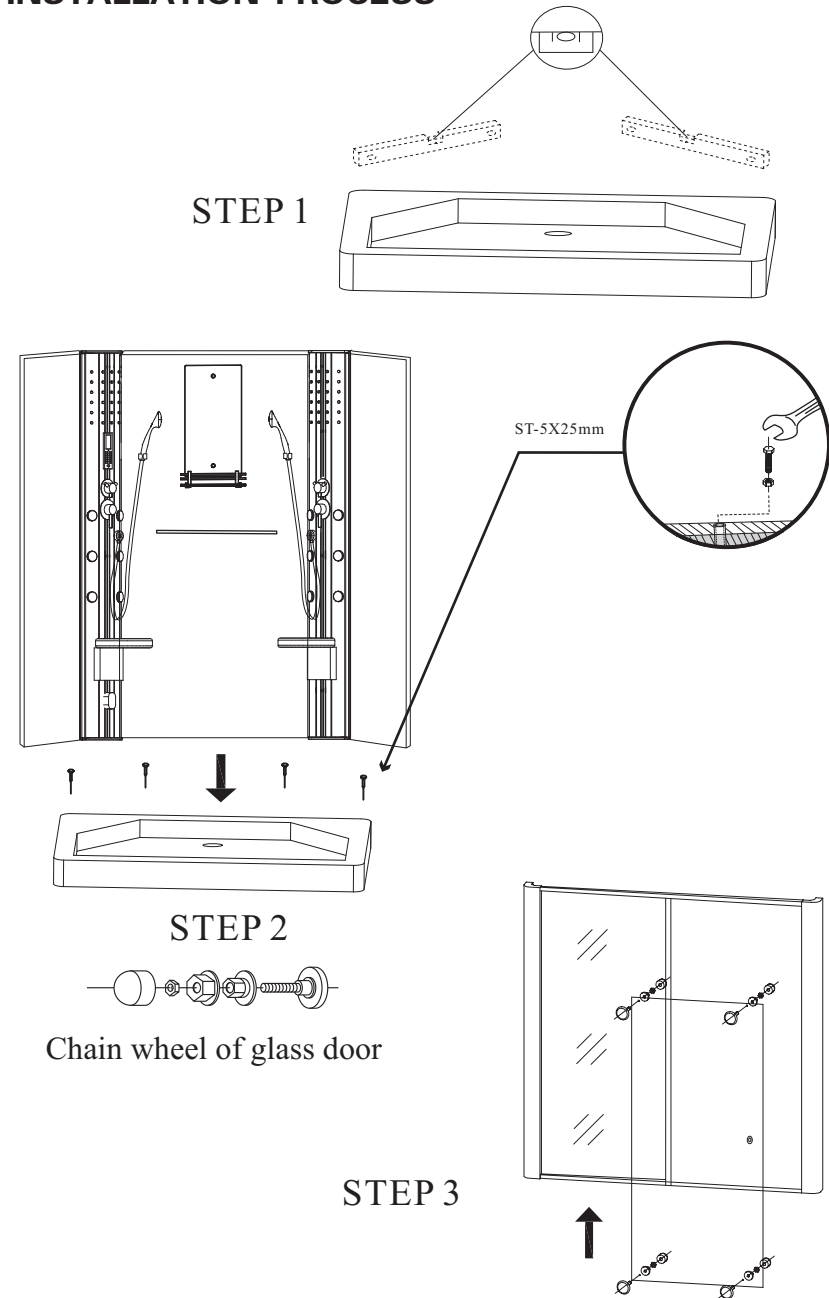

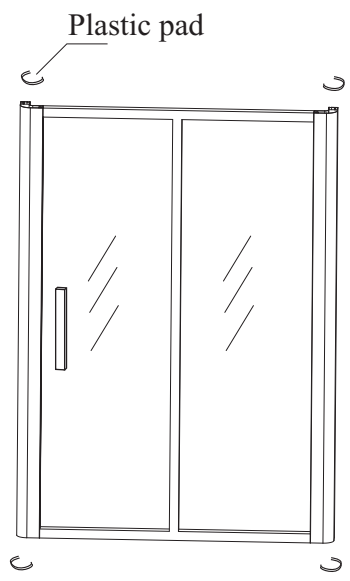

STEP 4

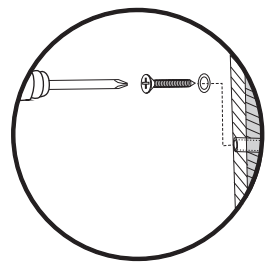

M4×15

STEP 5

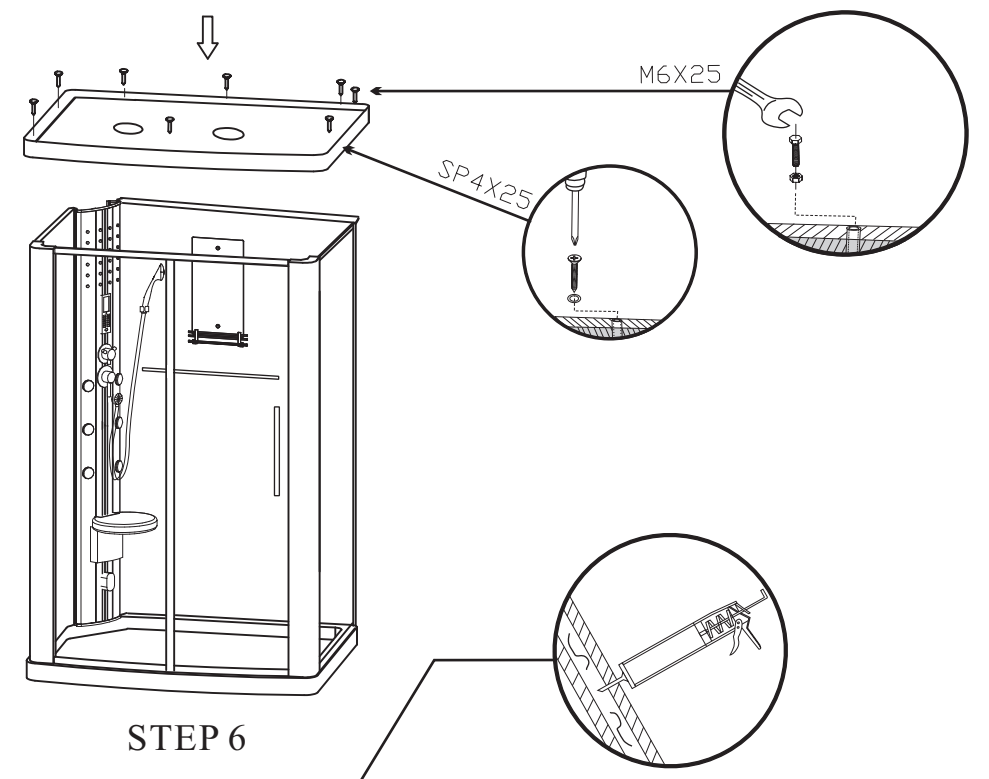

STEP 6

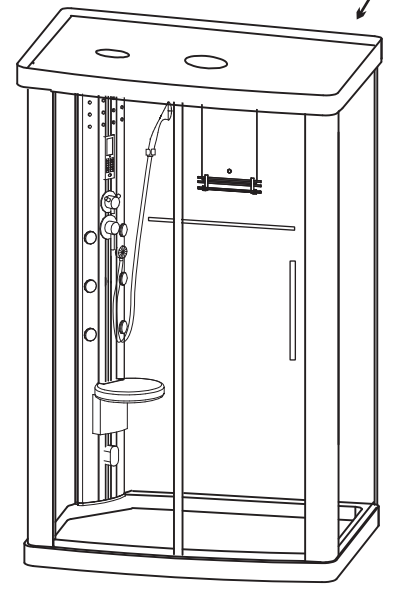

STEP 7